

Flat Flexible Cables and Flat Cable Assemblies



Contents

General Information

Introduction	2
Applications	4
Advantages	4
Production	5
Packaging	5
Storage conditions	5
Quality assurance	6
Design, Research, Innovation & Development	6
Connection	7
Connection with connectors	7
Shielding efficiency	8
Flex-life	9
Gold plated Flat Flexible Cables	10
Custom-designed Flat Flexible Cables	10

Flat Flexible Cables AXOJUMP®

0.30 mm pitch Flat Flexible Cables

General characteristics	12
General drawing	12
Connection scheme	12
Processing forms	13
Dimensions	13
Electrical properties	14
Other properties	14
Identification code	15

0.50, 1.00 and 1.25 mm pitch 100 micron conductors

General characteristics	16
Connection schemes	16
General drawing	17
Processing forms	17
Dimensions	17
Electrical properties	18
Other properties	18
UL compliance	19
Special designs	19
Identification code	20

0.50, 1.00 and 1.25 mm pitch 50 and 35 micron conductors

General characteristics	21
Connection schemes	21
General drawing	22
Processing forms	22
Dimensions	22
Electrical properties	23
Other properties	23
UL compliance	24
Special designs	24
Identification code	25

Shielded Flat Flexible Cables

General characteristics	26
Connection schemes	26
General drawing	27
Processing forms	27
Dimensions	27
Electrical properties	28
Other properties	28
UL compliance	29
Identification code	30

Flat Cables with round pins AXOSTRIP®

Advantages	31
General characteristics	31
Processing forms	32
Dimensions	32
Type of insulation tape	33
Electrical properties	33
UL approval	33
Identification code	33

Bulk Flat Flexible Cables FLEXLINK®

Standard bulk Flat Cables

Advantages	34
General characteristics	34

General drawing	34
Dimensions	34
Electrical properties	35
Special assemblies	35
Identification code	35

Custom-designed cables for switch rotary connectors

General characteristics	36
Processing forms	36

Flat Display Connections AXOLINK®

Advantages	37
General characteristics	37
Product availability	37
Processing forms	38
Dimensions	40
Off-the-shelf products	40
Quick prototyping for electrical validation	41
Special products	41
Identification code	42

Flat Display Connections for High Speed (LVDS) and Ultra High Speed (UHS) transmission FDC 100®

Advantages	43
General characteristics	43
General drawing	43
FDC 100® with FI-R connectors	44
FDC 100® for ZIF connectors	47
Special designs	48
Identification code	48



General Information

AXON[®], manufacturer of cables and interconnect solutions for advanced technologies, offers a complete range of Flat Cables and Assemblies :

- > FFC-Flat Flexible Cables
AXOJUMP[®],
- > Flat Cables with round pins
AXOSTRIP[®],
- > Bulk Flat Flexible Cables
FLEXLINK[®],
- > FDC-Flat Display Connections
AXOLINK[®].
- > Flat Display Connections
for High Speed (LVDS)
and Ultra High Speed (UHS)
transmission
FDC 100[®].

From standard Flat Cables to custom designed Assemblies, AXON[®] harnesses a wealth of expertise to meet challenging customer requirements.

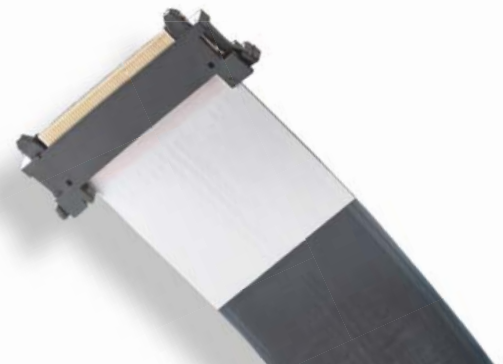

FFC- Flat Flexible Cables: AXOJUMP®

Designed for board-to-board interconnections, AXOJUMP® standard Flat Flexible Cables are made up of flat conductors insulated with Polyester or Polyimide tapes (from 0.30 mm to 1.25 mm pitch).

AXON' has developed a wide range of custom designed Flat Flexible Cables incorporating folds, shields, notches, punching, slitting and marking.

The termination of Flat Flexible Cables is made either:

- with ZIF (Zero Insertion Force) / LIF (Low Insertion Force) connectors: the cables are equipped with reinforcement tape to strengthen the ends,
- by soldering.



FLAT FLEXIBLE CABLES FOR LIF CONNECTOR

Flat Cables with round pins: AXOSTRIP®

AXOSTRIP® - Flat Cables with round pins can be soldered or inserted to achieve board-to-board interconnections.

Bulk Flat Flexible Cables: FLEXLINK®

FLEXLINK®-Bulk Flat Flexible Cables are made with flat conductors insulated with Polyester film. They are used for any application where space reduction and flexibility are the most important criteria. The termination of Flat Bulk Cables is made with crimped contacts.



FLAT CABLES WITH ROUND PINS

FDC- Flat Display Connections: AXOLINK®

AXOLINK®-FDC-Flat Display Connections have been designed for board to display interconnections. They consist of AXOJUMP® standard Flat Flexible Cables and connectors such as: DF-9, DF-19, FI-SE, FI-X at one or both ends.

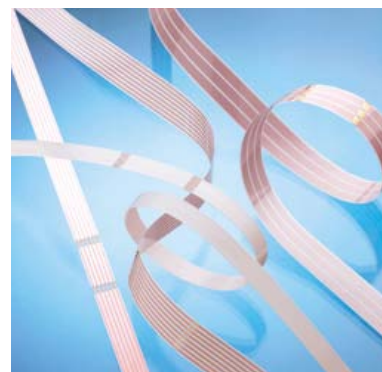

BULK FLAT FLEXIBLE CABLES

Flat Display Connections for High Speed (LVDS) and Ultra High Speed (UHS) transmission: FDC 100®

A special range called FDC 100® has also been developed for connecting full HD and ultra high definition displays with LVDS (Low Voltage Differential Signaling) and V-by-One® HS protocol. This assembly consists of a 21, 31, 41 or 51 way 0.50 mm pitch shielded flat cables, terminated with connectors compatible with the board-mount FI-R connectors. Cables are compatible with ZIF Molex and FH41 Hirose connectors.



FDC-FLAT DISPLAY CONNECTIONS

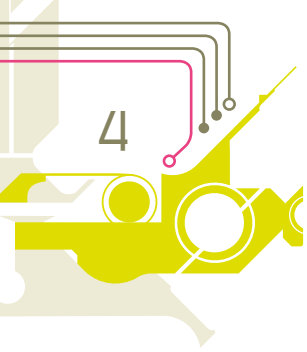

Applications

AXON' Flat Cables and Assemblies can be used in numerous application areas:

- ▶ **Automotive industry**
car radios, GPS systems, switch rotary connectors, headliners, door panels.
- ▶ **Medical applications**
- ▶ **Consumer electronics**
CD and DVD players, TV, LCD displays, hi-fi systems, satellite receivers and decoders.
- ▶ **Telecommunications**
telephones, fax machines.
- ▶ **IT equipment**
notebooks, scanners, printers.
- ▶ **Household equipment**
glass-ceramic cooking plates, refrigerators, dishwashers.
- ▶ **Military electronics**
missiles, weapon systems.
- ▶ **Robotic applications**
- ▶ **Aeronautics**
LCD displays, electronic devices.

Advantages

AXON' Flat Cables and Assemblies offer many advantages:

- Extremely small dimensions:
low profile - narrow width - fine pitch,
- Simple and fast installation:
time saving - cost reduction,
- Compatible with ZIF/LIF connectors,
- Excellent flexibility and flex-life,

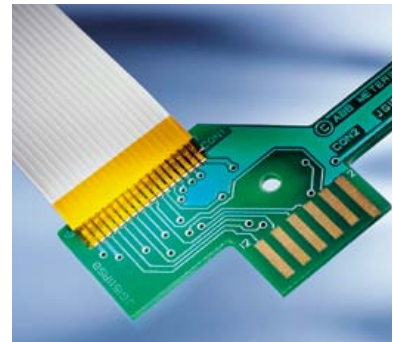

CONNECTION BY SOLDERING



FLAT DISPLAY CONNECTION

Production

AXOJUMP® Flat Flexible Cables are manufactured in AXON's production sites in Europe and Asia, using state-of-the-art manufacturing equipment.

AXON' specialises in FFC manufacturing ranging from wire drawing, plating and rolling of conductors to insulation, final cutting and shielding.

Conductor manufacturing

AXON' manufactures its own flat conductors. The main materials used are:

- Bare copper,
- Tin alloy plated copper,
- Gold plated copper.

AXON's expertise in conductors allows for a wide range of flat cables with different levels of flexibility.

The modern manufacturing equipment allows perfect dimensional precision, electrical resistance control and production of long continuous lengths.

Cable insulation

AXON' insulates the conductors with laminated Polyester or Polyimide tapes.

Packaging

Each container is marked with the following:

- AXON' CABLE.
- Reference of the product.
- Batch number.
- Quantity.

Storage conditions

- Pieces packaged in original packaging.
- Temperature: -20°C to 40°C.
- Relative humidity: 70 % max.
- Storage duration:
 - 1 year max. (tin plated conductors).
 - 3 years max. (gold plated conductors).



FLAT COPPER CONDUCTOR



FLAT CABLE INSULATION



FLAT CABLE WORKSHOP

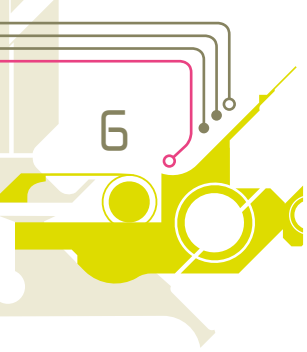

Quality assurance

AXON' is accredited to:

- ISO 9001,
- ISO TS 16949,
- ISO 14001,
- EN 9100,
- OHSAS 18001,
- ISO 13485.

AXON's continuous improvement plan called "SOLON" is based on the EFQM model (European Foundation for Quality Management).

In addition to in-line controls throughout the manufacturing area, AXON' applies "Statistical Process Control" methods (SPC) as well as standard problem solving and continuous improvement methods. TPM (Total Productive Maintenance) is applied in order to improve productivity.

AXON' conforms to the latest RoHS European Directives and REACH regulation. Please consult our website for the latest information:

www.axon-cable.com/Customer Area/RoHS and EU directives.

In addition, AXON's products have been recorded in the IMDS database (International Material Data System) since 2003, in which the make-up of product is indicated.

Design, Research, Innovation and Development

At the company's headquarters, as well as in each country where AXON' has a subsidiary - Germany, Great Britain, USA, Latvia, Hungary, China, Mexico, India, Brazil - engineering teams provide local technical support.

The Research and Development Department located in France concentrates on the following areas:

Metal technologies

- Metal plating of the conductors,
- Drawing - Laminating - Annealing.

Plastics technology

- Insulation - Jacketing,
- Moulding - Overmoulding.

Electronics

- EMI/EMC,
- RF and high speed data.

Interconnection technology

- Soldering,
- Welding,
- Contact crimping
- Connectors.

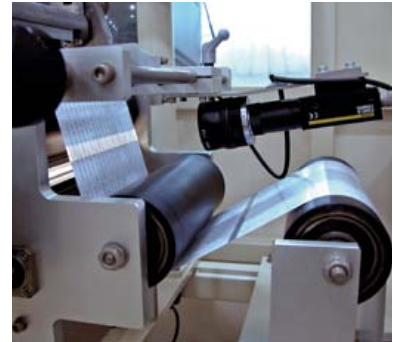

IN-LINE CONTROLS



ENGINEERING DEPARTMENT

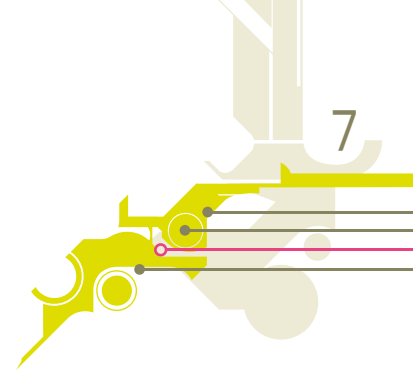

Connection

Connection with connectors

AXON' flat cables are designed for LIF (Low Insertion Force) or ZIF (Zero Insertion Force) connectors from most connector manufacturers.

Connection with crimped contacts

1.27 and 2.54 mm pitch FFC's can be terminated with crimped contacts or provided ready for crimping.

Connection with soldering

Reflow soldering is suited for termination of flat cables to printed circuit boards.

AXON' uses a semi-automatic hot bar soldering process to manufacture FFC/PCB connections. The two parts are assembled using a thermode.

► Recommended PCB configuration

- Tin thickness on the soldering pads:
5 to 8 μm for 0.5 and 0.8 mm pitch FFC.
10 to 15 μm for 1.00 and 2.54 mm pitch FFC.
- Tinning material: tin-copper alloy.

The hot bar soldering process

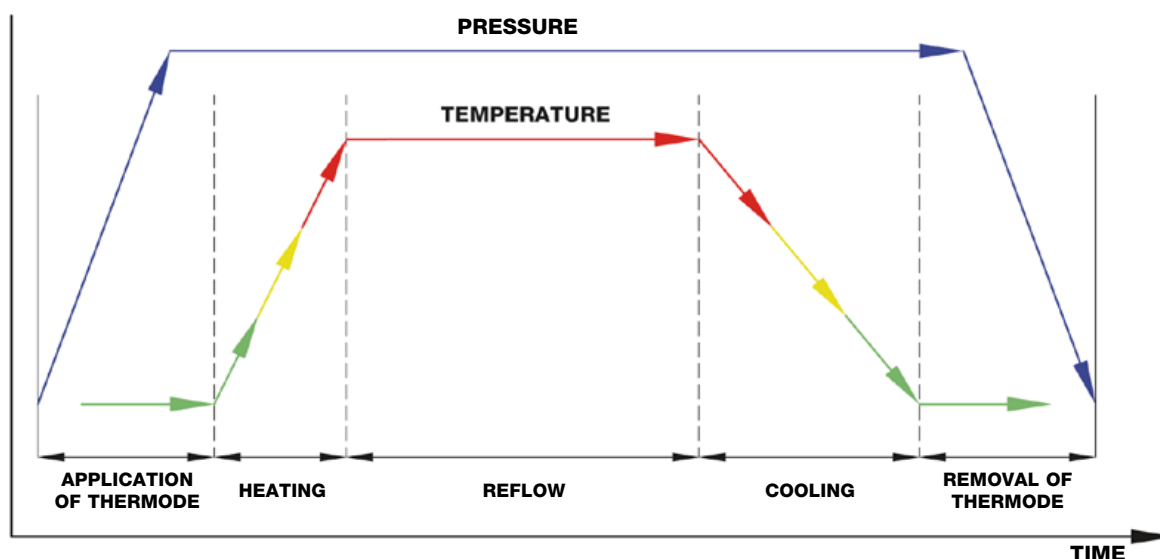

Connection with connectors

AXON' offers flat cables for connectors with a locking system. Specially punched FFC's maximise stability. Used with a robust housing, it prevents warping.

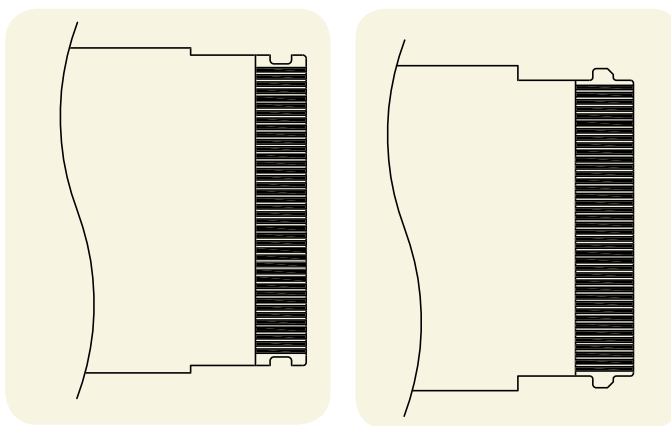

AXON' punching process is camera-driven for a very high degree of precision.

AXON' can develop specific punched shapes as required.

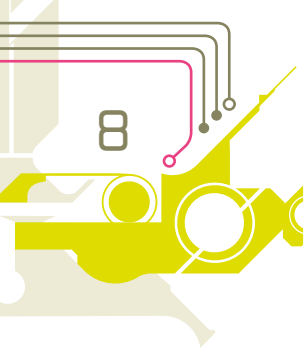

Shielding expertise

AXON' offers shielded flat cables with aluminium tape. The company is able to ground one or several conductors to the shield (same voltage level and EMI performance).

To characterize the shielding of flat or round cables, AXON' uses the "Transfer Impedance Z_T " parameters, expressed in ohms/m. As this notion depends on the type of product, rather than on the application, it is better suited to accurately characterize shielding performance than the alternative notion of "shielding efficiency", given in dB.

AXON' is equipped with comprehensive test benches to characterize transfer impedance of round and flat cables as well as terminated harnesses.

Measurement of the shield resistance

Shielding efficiency is measured on a network analyser using the microstrip method.

The connection between the cable and the coaxial cable of the network analyser is made possible with an interface PCB which links the flat cable's ZIF connectors to the coaxial connectors.

AXON's standard shielded FFC's are usually used for static applications. For dynamic applications, please contact us for more details.



SHIELDED FLAT FLEXIBLE CABLES



MICROSTRIP INJECTION TEST BENCH TO CONTROL TRANSFER IMPEDANCE

Shielding efficiency

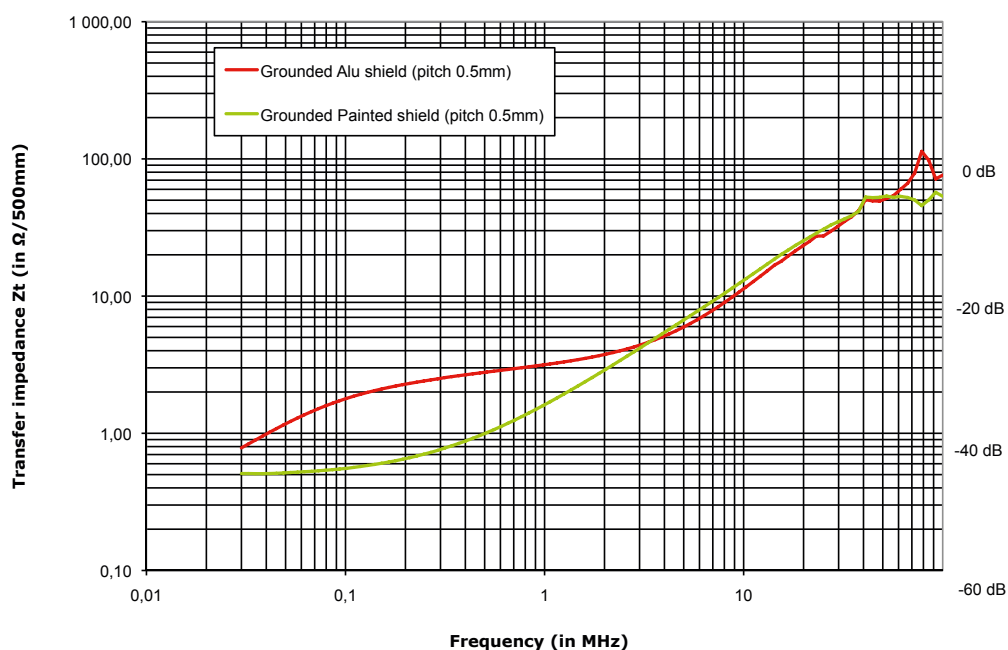

This graph shows the shielding efficiency of two different cables in terms of transfer impedance. The lower the transfer impedance (Z_T) the more efficient the shielding.

Flex-life

The flex-life of AXON' FFC's depends on the choice of conductor/insulation tape combination.

To meet the different requirements of flex life in dynamic applications, AXON' offers a range of FFC's to withstand an increasing number of flex cycles.

The sample is fitted between two plates. The bottom plate slides back and forth and the top one remains still. The cycle is repeated until the first conductor breaks.

The performance of our cables are defined in the datasheets in this brochure.

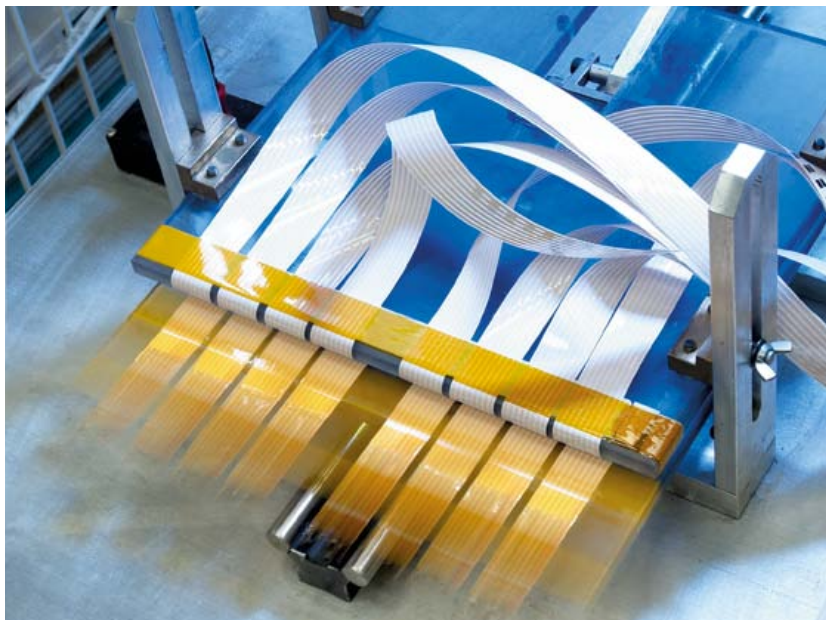

FLEX-LIFE TEST

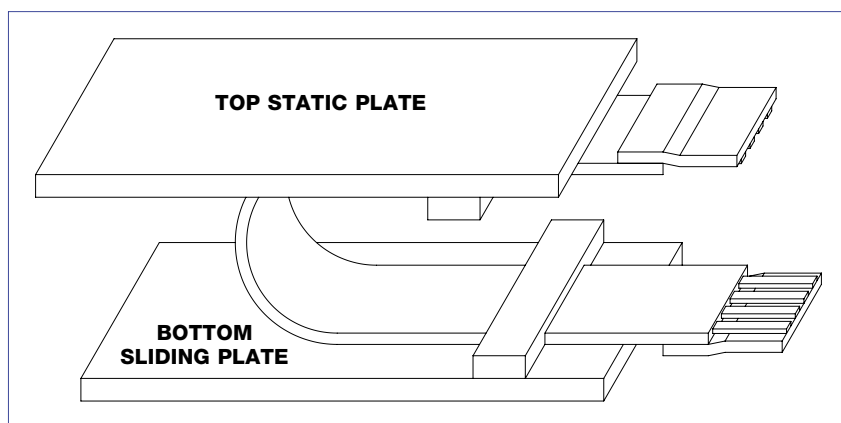

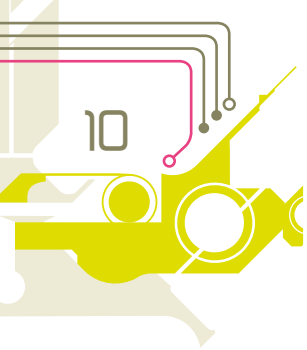

Gold plated Flat Flexible Cables

AXON' offers flat cables with a fine gold coating over nickel on the stripped ends. Gold coating guarantees the absence of tin whiskers. *Whiskers are filaments or knots which can grow from metal such as tin after several months, with the risk of producing short circuits between fine pitch conductors.* AXON' can offer stripped gold plated flat cables in different pitches compatible with a large range of gold contact connectors.

These gold plated cables have been designed for board-to-board interconnections in miniaturised electronic products, which require fine pitch flat cables.

Gold Plated stripped ends are coated with:

- nickel, 0.3µm min.
- and gold, 0.05µm min.

The nickel coating is a barrier to avoid the migration of gold into the copper. It also improves the protection of the conductors against corrosion.

Thanks to a flexible manufacturing process, AXON' can offer different thicknesses of nickel and gold plating depending on the application.

AXON' gold plated cables successfully withstand salt spray testing.

Custom-designed Flat Flexible Cables

AXON' is able to offer custom-designed Flat Flexible Cables such as :

- Ultraflex,
- 2.54 mm pitches,
- Hybrid pitches,
- Special reinforcement, (easy-to-insert, colour, ...),
- 300V cables,
- Black cables,
- Printed line on the cable to help for connector assembly.
- Folds,
- Specific printing on the insulation,
- Adhesive tapes for fixation.



GOLD PLATING AT EXPOSED ENDS



CUSTOM-DESIGNED FLAT FLEXIBLE CABLES WITH PRINTED LINE

Flat Cables

FFC-Flat Flexible Cables AXOJUMP®

Designed for board-to-board interconnections in electronic systems, Axojump® Flat Flexible Cables (FFC) are made up of flat tin or gold plated copper conductors insulated with Polyester or Polyimide tapes. From 0.30 mm pitch for space saving to 1.25 mm, a large variety of pitches is available to suit your needs. In addition to the standard range, AXON' has developed custom designed flat flex cables incorporating folds, shields, notches, punching, slitting or marking. Flat Flexible Cables are compatible with ZIF and LIF connectors.

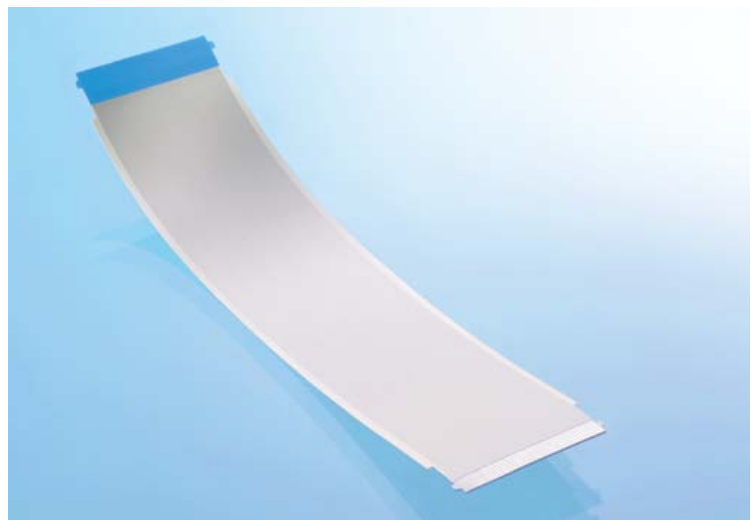

0.30 mm pitch Flat Flexible Cables

General characteristics

Temperature rating: up to 105°C.

Voltage rating: up to 30V AC.

Conductor

Pitch: 0.30 mm.

Width: 0.20 ± 0.015 mm.

Conductor thickness: 0.035 mm typical value.

Max. conductor resistance: 2800 (Ω /km) at 20°C.

Conductor plating

Gold: 0.3 μ m Ni (mini) / 0.05 μ m Au.

Insulation

Polyester insulation with flame retardant adhesive.

White colour.

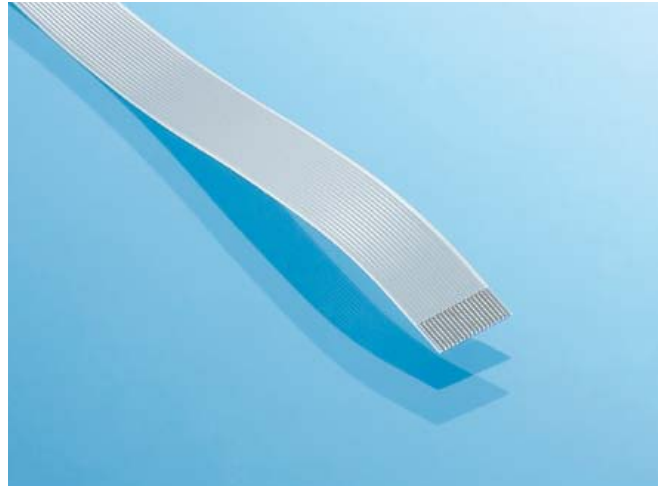

0.30 MM PITCH STANDARD FLAT FLEXIBLE CABLE.

Connection scheme

With ZIF connectors

- Reinforcement tape: Polyester L code.
- Blue colour.



General drawing

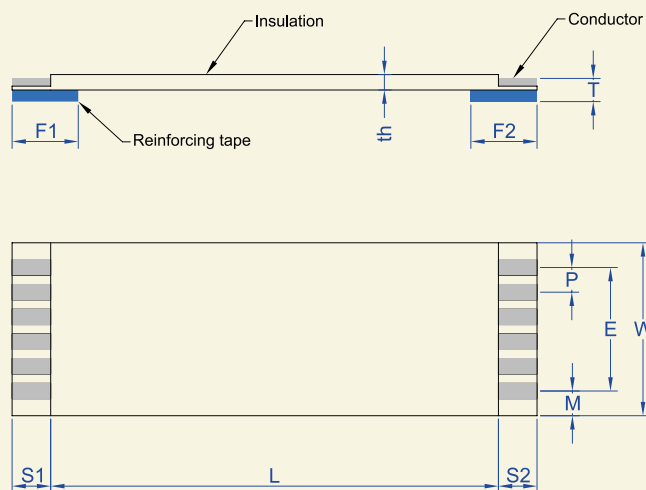

Processing forms

Type A

Reinforcements at both ends,
on the same side.

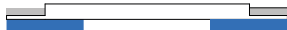

Type D

Reinforcements at both ends,
on opposing side.

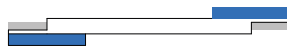

0.30 MM PITCH GOLD PLATED FLAT FLEXIBLE CABLE.

Dimensions

Pitch: P (mm)	0.30 ± 0.03
Number of conductors: N	11 to 51
Span: E (mm)	$(N-1) \cdot 0.30 \pm 0.03$
Width: W (mm) (on connection area)	$(N+1) \cdot 0.30 \pm 0.03$
Margin: M (mm)	0.30 ± 0.05
Strip length: S1-S2 (mm)	4.00 ± 0.80
Reinforcement length: F1-F2 (mm)	8.00 ± 2.00
Insulated length: L (mm)	42 to 60 ± 2 61 to 100 ± 3 101 to 200 ± 4 201 to 500 ± 5
Thickness at end of cable: T (mm)	0.20 ± 0.03
Cable thickness: th (mm)	0.12 (typical value)

0.30 mm pitch Flat Flexible Cables (continued)

Electrical properties

	Testing conditions	Values
Dielectric Test (V AC) - Min	In air, during 1 minute	100
Current rating (A) - Max	FFC at 23°C Allowable temperature rise : 40°C	0.30
Insulation resistance conductor to conductor		10 MW.m min at DC 100V
Continuity test	DC 3.0 V at 0.1mA	Passed
Impedance cond/cond balanced method (typical value)	FFC without shielding at 1MHz	145 Ω
Capacitance cond/cond balanced method (typical value)	FFC without shielding at 1KHz	70 pF/m

Other properties

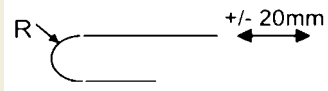
	Testing conditions	Characteristics	
Heat resistance	113°C, 168 hours	Dielectric test Insulation resistance	Passed Passed
Thermal shock	(-55°C x 30 min → 25°C x 5 min → 85°C x 30 min → 25°C x 5 min) x 25 cycles	Dielectric test Insulation resistance	Passed Passed
Cold coiling	-40°C, 96 hours The sample is initially wound on a mandrel of 3 mm	At room temperature: Visual inspection Dielectric test Insulation resistance	Passed Passed Passed
Wear by abrasion	Test following EN3475-503 Weight: 500 g Speed: 60 cycles/min Abrasion tool: Ø = 0.50 mm	Dielectric test Insulation resistance: After 500 cycles	Passed
Flame resistance	UL 758	VW-1	Passed
Folding	The specimen is folded manually at 180°	Continuity after more than 20 times	Passed
Moisture resistance	60°C, 95% RH, 96 hours	Dielectric test Insulation resistance	Passed Passed
Flex-life Number of cycles (typical values)	Speed 100 cycles /min Flex-life test is performed at 23°C. 	Radius 10 mm	500 000

Identification code

FFC 0.30 A 25/0200 E 4.0-4.0-08.0-08.0 E A LL/AU

Option:
Plating on conductors
AU: gold plating

Reinforcement type (F1 & F2):
L: Polyester reinforcement

UL compliance:
A: No compliance

Conductor thickness: **E** (35 microns)

Reinforcement **length F2** in mm
(8 mm standard length)

Reinforcement **length F1** in mm
(8 mm standard length)

Strip **length S2** in mm (4 mm standard length)

Strip **length S1** in mm (4 mm standard length)

Insulation: **E**

Insulation length **L** in mm

Number of conductors: **N**

Processing form: **A or D**

Pitch **P** in mm

Flat Flexible Cable

0.50, 1.00 and 1.25 mm pitch Flat Flexible Cables 100 micron conductors

General characteristics

Temperature rating: up to 105°C.

Voltage rating: up to 60V AC.

Conductor

Pitch (mm)	Width (mm)	Max conductor resistance (Ω /km) at 20°C	Conductor thickness (mm)
0.50	0.30 \pm 0.02	730	0.10 \pm 0.015
1.00	0.70 \pm 0.03	300	0.10 \pm 0.015
1.25	0.80 \pm 0.03	290	0.10 \pm 0.015

Conductor plating

Tin (with silver)	2 μ m mini
Gold	0.3 μ m Ni mini / 0.05 μ m Au

Insulation

Polyester insulation with flame retardant adhesive.

White colour.



0.50 MM PITCH STANDARD FLAT FLEXIBLE CABLE

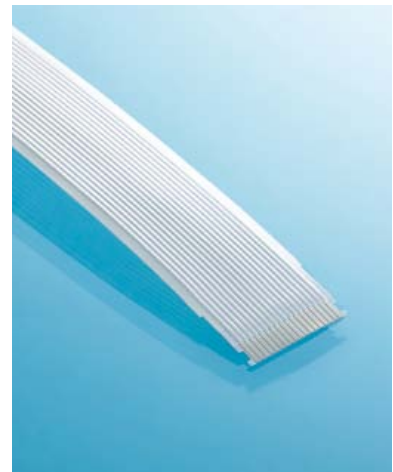

1.00 MM PUNCHED FLAT FLEXIBLE CABLE.

Connection schemes

With ZIF connectors

Reinforcement tape: Polyester K code.

Blue colour.



Hot bar soldering

Reinforcement tape: Polyimide H code.

Natural colour (amber).



Manual soldering

Code for the end: T.

F1 ; F2 = 2.50 mm.



General drawing

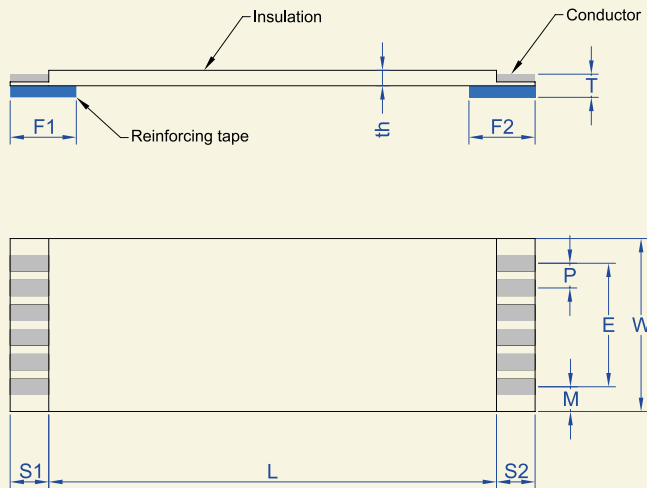

Processing forms

Type A

Reinforcements at both ends,
on the same side.

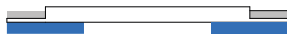

Type D

Reinforcements at both ends,
on opposing side.

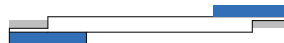

Dimensions

Pitch: P (mm)	0.50 ± 0.05	1.00 ± 0.08	1.25 ± 0.10
Number of conductors: N	6 to 80	4 to 60	4 to 60
Span: E (mm)	(N-1)*0.50 ± 0.10	(N-1)*1.00 ± 0.15	(N-1)*1.25 ± 0.15
Width: W (mm)	(N+1)*0.50 ± 0.06	(N+1)*1.00 ± 0.10	(N+1)*1.25 ± 0.15
Margin: M (mm)	0.50 + 0.15/-0.096	1.00 ± 0.20	1.25 ± 0.20
Strip length: S1-S2 (mm)	2.00 to 10.0 ± 0.80 (standard value: 4 mm)		
Reinforcement length: F1-F2 (mm)	6.00 to 20.0 ± 2.00 (standard value: 8 mm)		
Insulated length: L (mm)	20 to 60 ± 2 61 to 100 ± 3 101 to 200 ± 4		201 to 3999 ± 5 4000 to 5999 ± 10 6000 to 9999 ± 15
Thickness at end of cable: T (mm)	0.30 ± 0.05 (only for ZIF connectors)		
Cable thickness: th (mm)	0.25 typical		

0.50, 1.00 and 1.25 mm pitch Flat Flexible Cables 100 micron conductors (continued)

Electrical properties

	Testing conditions	Pitch		
		0.50	1.00	1.25
Dielectric Test (V AC) - Min	In air, during 1 minute (MIL-STD-202 Method 301)	200	400	500
Current rating (A) - Max	FFC at 23°C Allowable temperature rise: 40°C	0.55	1.25	1.40
Insulation resistance conductor to conductor (MΩ.m min)	MIL-STD-202F Method 302 cond. B	10 at DC 200V	10 at DC 400V	10 at DC 500V
Continuity test	DC 3.0 V at 0.1mA	Passed	Passed	Passed
Impedance cond/cond balanced method (typical value)	FFC without shielding at 1MHz	130 Ω	120 Ω	130 Ω
Capacitance cond/cond balanced method (typical value)	FFC without shielding at 1KHz	62 pF/m	50 pF/m	30 pF/m

Other properties

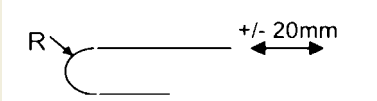
	Testing conditions	Characteristics	
Heat resistance	136°C, 168 hours	Dielectric test Insulation resistance	Passed Passed
Thermal shock	(-55°C x 30 min → 25°C x 5 min → 85°C x 30 min → 25°C x 5 min) x 25 cycles	Dielectric test Insulation resistance	Passed Passed
Cold coiling	-40°C, 96 hours The sample is initially wound on a mandrel of 3 mm	At room temperature: Visual inspection Dielectric test Insulation resistance	Passed Passed Passed
Wear by abrasion	Test following EN3475-503 Weight: 500 g Speed: 60 cycles/min Abrasion tool: Ø = 0.50 mm	Dielectric test Insulation resistance: After 10 000 cycles	Passed
Flame resistance	UL 758	VW-1	Passed
Solderability (tin plated conductors)	Immersion of the area which is intended for soldering into a tin bath at 250 ± 10°C During 30 seconds	No insulation separation Solder reflow below 1 mm	Passed Passed
Folding	The specimen shall be folded manually at 180°	Continuity after more than 20 times	Passed
Moisture resistance	60°C, 95% RH, 96 hours	Dielectric test Insulation resistance	Passed Passed
Flex-life (typical values)	speed 100 cycles /min Flex-life tests are performed at 23°C. 	Radius 10 mm	100 000 cycles



└ 0.50 MM PITCH GOLD PLATED FLAT FLEXIBLE CABLE

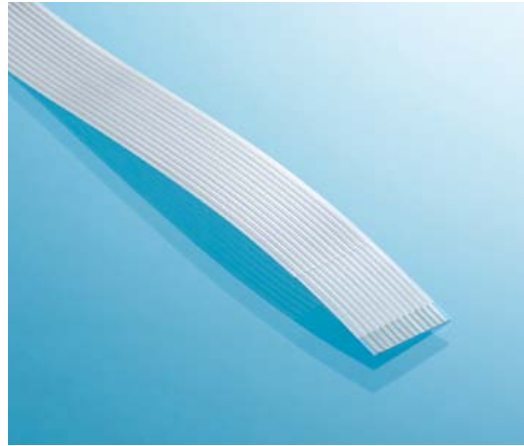

└ 1.25 MM PITCH FLAT FLEXIBLE CABLE

UL compliance

With code A: the products are UL compliant.

With code B: the products are UL certified style 20706 and shipped with UL labels.

Temperature rating: 105°C; Voltage rating: 60V AC.

AXON'Cable UL file number: E45046.



Marking definition on the cable:

FFC with L > 30 mm and W > 9mm will have black printing on one side with the following text:

"AXON'CABLE –  – AWM – STYLE 20706 – 105C – 60V – VW-1"

Special designs

Special designs available on request, such as specific shapes for connectors with locking systems.

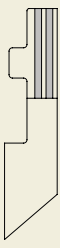
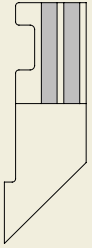
Pitch: P (mm)	0.50	0.50	0.50	0.50	1.00
FFC Drawing					

*0.50, 1.00 and 1.25 mm pitch Flat Flexible Cables
100 micron conductors (continued)*

Identification code

FFC 1.00 A 25/0200 B 4.0-4.0-08.0-08.0 S A KK/AU

Options:

Plating on conductors
-: tin plating
AU: gold plating

Reinforcement type (F1 & F2):

K: Polyester reinforcement
H: Polyimide reinforcement
T: Manual soldering

UL compliance:

A: Without UL marking
B: UL certified 20706

Conductor thickness: s

(100 microns)

Reinforcement **length F2** in mm
(8 mm standard length)

Reinforcement **length F1** in mm
(8 mm standard length)

Strip **length S2** in mm (4 mm standard length)

Strip **length S1** in mm (4 mm standard length)

Insulation: **B**

Insulation length **L** in mm

Number of conductors: **N**

Processing form: **A or D**

Pitch **P** in mm

Flat Flexible **Cable**

0.50, 1.00 and 1.25 mm pitch Flat Flexible Cables 50 and 35 micron conductors

General characteristics

Temperature rating: up to 105°C.

Voltage rating: up to 60V AC.

Conductor

Pitch (mm)	Width (mm)	Max Conductor Resistance (Ω /km) at 20°C	
		Flexible	Extra flexible
0.50	0.30 ± 0.02	1460	2200
1.00	0.70 ± 0.03	550	790
1.25	0.80 ± 0.03	540	740
Conductor thickness (typical value)		0.05 mm	0.035 mm

Conductor plating

Tin (with Silver)	2 μ m min
Gold	0.3 μ m Ni min / 0.05 μ m Au

Insulation

Polyester insulation with flame retardant adhesive.

White colour.

Connection schemes

With ZIF connectors

Reinforcement tape: Polyester B code.

Blue colour.



Hot bar soldering

Reinforcement tape: Polyimide H code.

Natural colour (amber).



*0.50, 1.00 and 1.25 mm pitch Flat Flexible Cables
50 and 35 micron conductors (continued)*

General drawing

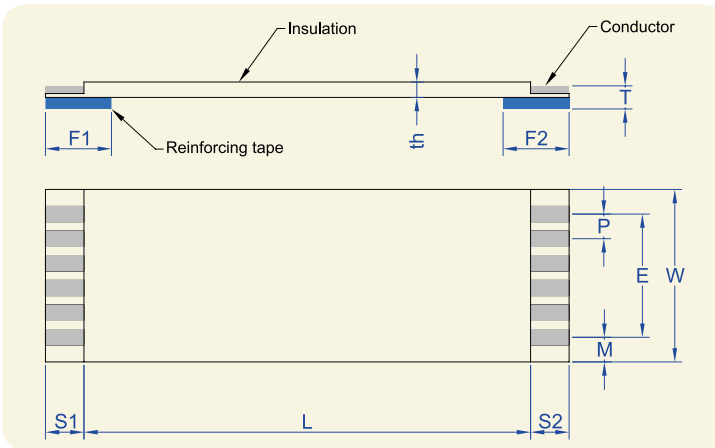

Processing forms

Type A

Reinforcements at both ends,
on the same side.

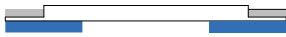

Type D

Reinforcements at both ends,
on opposing side.

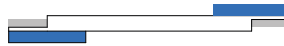

Dimensions

Pitch: P (mm)	0.50 ± 0.05	1.00 ± 0.08	1.25 ± 0.10
Number of conductors: N	6 to 80	4 to 60	4 to 60
Span: E (mm)	$(N-1) \cdot 0.50 \pm 0.10$	$(N-1) \cdot 1.00 \pm 0.15$	$(N-1) \cdot 1.25 \pm 0.15$
Width: W (mm)	$(N+1) \cdot 0.50 \pm 0.06$	$(N+1) \cdot 1.00 \pm 0.10$	$(N+1) \cdot 1.25 \pm 0.15$
Margin: M (mm)	0.5 +0.15/-0.096	1.00 ± 0.20	1.25 ± 0.20
Strip length: S1-S2 (mm)	2.00 to 10.0 ± 0.80 (standard value: 4 mm)		
Reinforcement length: F1-F2 (mm)	6.00 to 20.0 ± 2.00 (standard value: 8 mm)		
Insulated length: L (mm)	20 to 60 ± 2 61 to 100 ± 3 101 to 200 ± 4		201 to 3999 ± 5 4000 to 5999 ± 10 6000 to 9999 ± 15
Thickness at end of cable: T (mm)	0.30 ± 0.05 (only for ZIF connectors)		
Cable thickness: th (mm)	Flexible: 0.14 / Extra flexible: 0.12 (typical value)		

Electrical properties

	Testing conditions	Pitch		
		0.50	1.00	1.25
Dielectric Test (V AC) - Min	In air, during 1 minute	200	400	500
Current rating (A) - Max Flexible conductor	FFC at 23°C Allowable temperature rise : 40°C	0.40	0.80	0.85
Current rating (A) - Max Extra flexible conductor		0.35	0.80	0.80
Insulation resistance conductor to conductor (MΩ.m min)		10 at DC 200V	10 at DC 400V	10 at DC 500V
Continuity test	DC 3.0 V at 0.1mA	Passed	Passed	Passed
Impedance cond/cond balanced method (typical value)	FFC without shielding at 1MHz	150 Ω	150 Ω	170 Ω
Capacitance cond/cond balanced method (typical value)	FFC without shielding at 1KHz	50 pF/m	40 pF/m	35 pF/m

Other properties

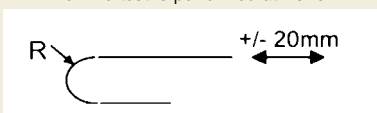
	Testing conditions	Characteristics		
Heat resistance	136°C, 168 hours	Dielectric test Insulation resistance	Passed Passed	
Thermal shock	(-55°C x 30 min → 25°C x 5 min → 85°C x 30 min → 25°C x 5 min) x 25 cycles	Dielectric test Insulation resistance	Passed Passed	
Cold coiling	-40°C, 96 hours The sample is initially wound on a mandrel of 3 mm	At room temperature: Visual inspection Dielectric test Insulation resistance	Passed Passed Passed	
Wear by abrasion	Test following EN3475-503 Weight: 500 g Speed: 60 cycles/min Abrasion tool: Ø = 0.50 mm	Dielectric test Insulation resistance: After 500 cycles	Passed	
Flame resistance	UL 758	VW-1	Passed	
Solderability (tin plated conductors)	Immersion of the area which is intended for soldering into a tin bath at 250 ± 10°C During 30 seconds	No insulation separation Solder reflow below 1 mm	Passed Passed	
Folding	The specimen shall be folded manually at 180°	Continuity after more than 20 times	Passed	
Moisture resistance	60°C, 95% RH, 96 hours	Dielectric test Insulation resistance	Passed Passed	
Flex-life Number of cycles (typical values)	Speed 100 cycles /min Flex-life test is performed at 23°C. 	Radius	5 mm	10 mm
		Flexible	20 000	2 500 000
		Extra flexible	100 000	5 000 000

0.50, 1.00 and 1.25 mm pitch Flat Flexible Cables
50 and 35 micron conductors (continued)



0.50 MM PITCH STANDARD FLAT FLEXIBLE CABLE



0.50 MM PITCH PUNCHED FLAT FLEXIBLE CABLE

UL compliance

With code A: the products are UL compliant.

With code B: the products are UL certified style 20706 and shipped with UL labels.

Temperature rating: 105°C; Voltage rating: 60V AC.

AXON'Cable UL file number: E45046.



Marking definition on the cable:

FFC with L > 30 mm and W > 9mm will have black printing on one side with the following text:

"AXON'CABLE –  – AWM – STYLE 20706 – 105C – 60V – VW-1"

Special designs

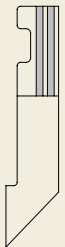
Special designs available on request, such as specific shapes for connectors with locking systems.

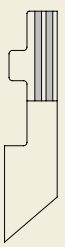
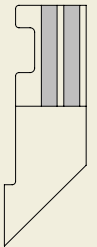
Pitch: P (mm)	0.50	0.50	0.50	0.50	1.00
FFC Drawing					

Identification code

FFC 1.00 A 25/0200 E 4.0-4.0-08.0-08.0 F A BB/AU

Options:

Plating on conductors
-: tin plating
AU: gold plating

Reinforcement type (F1 & F2):

B: Polyester reinforcement
H: Polyimide reinforcement
-: no tape (not for pitches 0.50/1.00 mm)

UL compliance:

A: Without UL marking
B: UL certified 20706

Conductor thickness:

F: Flexible (50 microns)
E: Extra flexible (35 microns)

Reinforcement **length F2** in mm
(8 mm standard length)

Reinforcement **length F1** in mm
(8 mm standard length)

Strip **length S2** in mm (4 mm standard length)

Strip **length S1** in mm (4 mm standard length)

Insulation: **E**

Insulation length **L** in mm

Number of conductors: **N**

Processing form: **A or D**

Pitch **P** in mm

Flat Flexible Cable

Shielded Flat Flexible Cables

General characteristics

Temperature rating: up to 80°C.

Voltage rating: up to 60 V AC.

Conductor

Pitch (mm)	Width (mm)	Max Conductor Resistance (Ω /km) at 20°C
0.50	0.30 ± 0.02	1460
1.00	0.70 ± 0.03	550
Conductor thickness (Typical value)		0.05 mm

Conductor plating

Tin (with Silver)	2 μ m min
Gold	0.3 μ m Ni min / 0.05 μ m Au

Insulation

Polyester insulation with flame retardant adhesive.

White colour.

Shielding

Painted Shielding for 0.50 mm pitch FFC.

Aluminium tape with Polyester insulation for 1.00 mm pitch FFC..

Grey colour.

Connection scheme

With ZIF connectors

Polyester type B reinforcement tape.

Blue colour.



General drawing

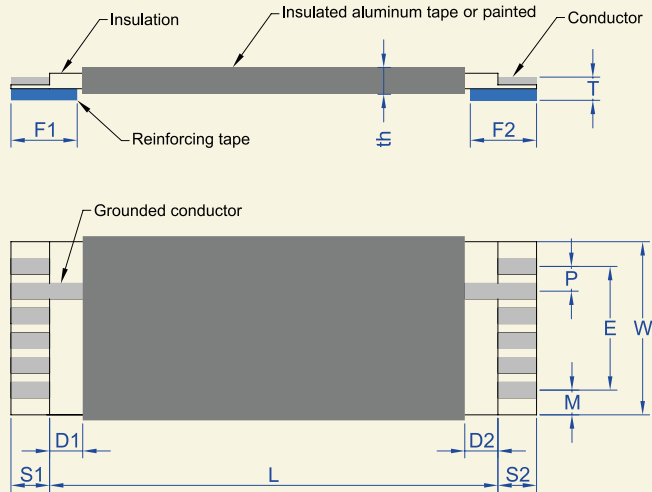

Processing forms

Type A

Reinforcements at both ends, on the same side.

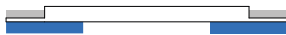

Type D

Reinforcements at both ends, on opposing side.

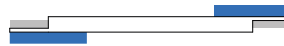

Dimensions

Pitch: P (mm)	0.50 ± 0.05	1.00 ± 0.08
Number of conductors: N	13 to 60	6 to 30
Span: E (mm)	(N-1)*0.50 ± 0.10	(N-1)*1.00 ± 0.15
Width: W (mm)	(N+1)*0.50 ± 0.10	(N+1)*1.00 ± 0.10
Margin: M (mm)	0.50 +0.15/-0.096	1.00 ± 0.20
Strip length: S1-S2 (mm)	2.00 to 10.0 ± 0.80 (standard value: 4 mm)	
Shielding position: D1-D2(mm)	4 ± 3	
Reinforcement length: F1-F2 (mm)	6.00 to 20.0 ± 2.00 (standard value: 8 mm)	
Insulated length: L (mm)	40 to 60 ± 2 61 to 100 ± 3 101 to 200 ± 4 201 to 1100 ± 5	
Thickness at end of cable: T (mm)	0.30 ± 0.05	
Cable thickness: th (mm)	0.25 (typical value)	0.28 (typical value)

Shielded Flat Flexible Cables (continued)

Electrical properties

	Testing conditions	Pitch	
		0.50	1.00
Dielectric Test (V AC) - Min	In air, during 1 minute (MIL-STD-202 Method 301)	200	400
Current rating (A) - Max FFC at 23°C Allowable temperature rise: 40°C	Flexible conductor	0.50	1.00
Insulation resistance conductor to conductor (MΩ.m min)	MIL-STD-202F Method 302 cond. B	10 at DC 200V	10 at DC 400V
Continuity test	DC 3.0 V at 0.1mA	Passed	Passed
Impedance cond/cond balanced method (typical value)	FFC without shielding at 1MHz	67 Ω	60 Ω
Impedance cond/shielding (typical value)	FFC with shielding at 1MHz	45 Ω	40 Ω
Capacitance cond/cond balanced method (typical value)	FFC without shielding at 1 KHz	230 pF/m	220 pF/m
Capacitance cond / shielding (typical value)	FFC with shielding at 1KHz	470 pF/m	500 pF/m

Other properties

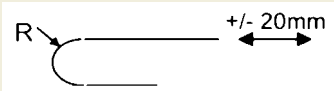
	Testing conditions	Characteristics	
Heat resistance	113°C, 168 hours	Dielectric test Insulation resistance	Passed Passed
Thermal shock	(-55°C x 30 min → 25°C x 5 min → 85°C x 30 min → 25°C x 5 min) x 25 cycles	Dielectric test Insulation resistance	Passed Passed
Cold coiling	-40°C, 96 hours The sample is initially wound on a mandrel of 3 mm	At room temperature: Visual inspection Dielectric test Insulation resistance	Passed Passed Passed
Wear by Abrasion	Test following EN3475-503 Weight: 500 g Speed: 60 cycles/min Abrasion tool: Ø = 0.50 mm	Dielectric test Insulation resistance: after 500 cycles	Passed
Flame resistance	UL 758	VW-1	Passed
Solderability (tin plated conductors)	Immersion of the area which is intended for soldering into a tin bath at 250 ± 10°C During 30 seconds	No insulation separation Solder reflow below 1 mm	Passed Passed
Folding	The specimen shall be folded manually at 180°	Continuity after more than 20 times	Passed
Moisture resistance	60°C, 95% RH, 96 hours	Dielectric test Insulation resistance	Passed Passed
Flex-life Number of cycles (typical values)	Speed 100 cycles /min Flex-life test is performed at 23°C. 	Radius 10 mm	100 000 cycles

UL compliance

With code A: the products are UL compliant.

With code B: the products are UL certified style 20624 and shipped with UL labels.

Temperature rating: 80°C; Voltage rating: 60V AC.

AXON'Cable UL file number: E45046.

Marking definition on the cable:

FFC with L > 30 mm and W > 9mm will have black printing on one side with the following text:

"AXON'CABLE –  – AWM – STYLE 20624 – 80C – 60V – VW-1"



SHIELDED FLAT FLEXIBLE CABLES

Shielded Flat Flexible Cables (continued)

Identification code

FFC 0.50 A 50 / 0200 C 4.0-4.0-08.0-08.0 F A BB/AU/G1 - 10

Shielding:

S: Shielding without grounded
G: Grounded shielding + n° of grounded conductor (max 4 and no adjacent conductors)

Options:

Plating on conductors
 -: tin plating
AU: gold plating

Reinforcement type (F1 & F2):

B: Polyester reinforcement

UL compliance:

A: Without UL marking
B: UL certified 20624

Conductor thickness:

F: Flexible

Reinforcement **length F2** in mm
 (8 mm standard length)

Reinforcement **length F1** in mm
 (8 mm standard length)

Strip **length S2** in mm (4 mm standard length)

Strip **length S1** in mm (4 mm standard length)

Insulation:

B (for pitch of 1mm)
C (for pitch of 0.5mm)

Insulation length **L** in mm

Number of conductors: **N**

Processing form: **A or D**

Pitch **P** in mm

Flat Flexible Cable

Flat Cables with round pins AXOSTRIP®

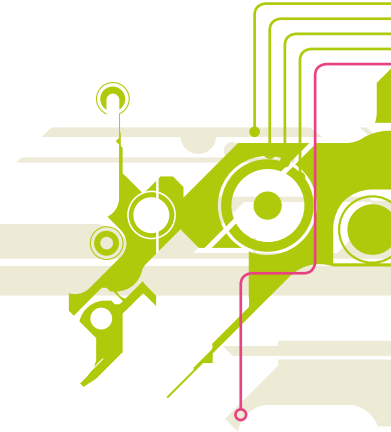

AXOSTRIP® is a flat cable with round pins which can be soldered or inserted to achieve board-to-board interconnections.

Advantages

- High flexibility,
- High resistance to vibration and bending: reliable connection joint,
- Lower production costs: wave-soldered with the other components onto the PCB in the same operation,
- Lower purchasing costs since no connectors are required for type C,
- Type B is dismantlable, only one connector is needed,
- Preparation wire stripping and cutting to length is not required,
- ZIF interface if needed (when flat conductors on one end).



General characteristics



ARAMID INSULATED AXOSTRIP®

Conductor

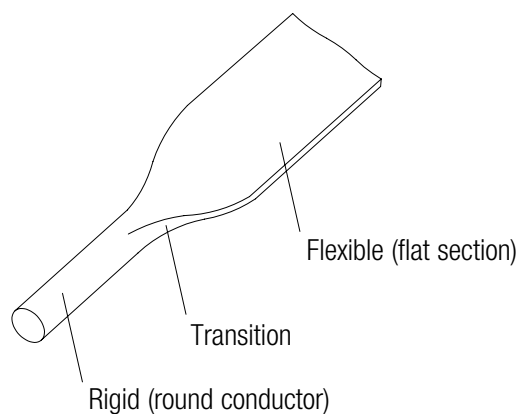

Insulation

Polyester, Polyimide or Aramid.

Processing forms

Type B

Tin plated copper round conductors on one end with flat conductors on the other end.

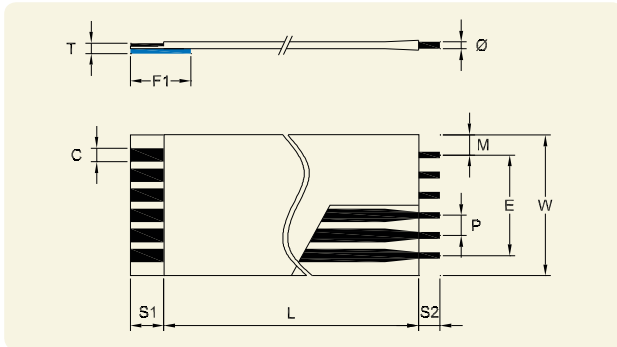

STANDARD RFC TYPE B

Type C

Tin plated copper round conductors on both ends, straight on both sides.

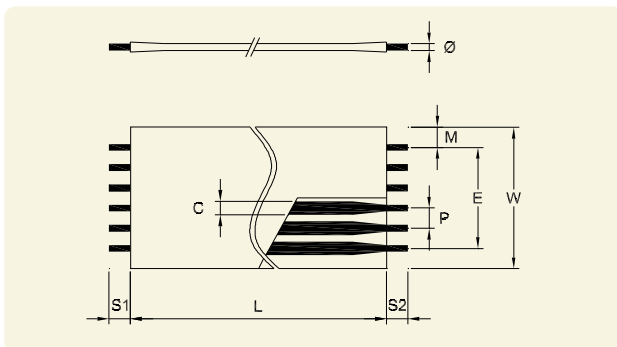

STANDARD RFC TYPE C

$$E = (N-1) \times P,$$

$$W = (N+1) \times P,$$

Where P = pitch,
 N = Number of conductors

Dimensions

Pitch P (mm)	1.00	1.25/1.27	1.90	2.00	2.54	5.08
Max. number of conductors	50	50	38	37	32	13
Insulated length (mm) L	15 to 999					
Pin diameter (mm) \varnothing	0.32	0.32	0.40	0.40	0.51	0.51
Standard wire gauge (AWG)	28	28	26	26	24	24
Flat conductor width (mm) C	0.7	0.8	1.3	1.3	1.5	1.5
Flat conductor thickness (mm)	0.115	0.10	0.10	0.10	0.12	0.12
Margin (mm) M	1.00	1.25/1.27	1.905	2.00	2.54	2.54

Other pitches and designs available on request.

Type of insulation tape

Pitch P (mm)		1.00	1.25/1.27	1.90	2.00	2.54	5.08
Insulation tape	Polyester 105°C	B		H			
	Aramid 125°C	W					
	Polyimide 125°C	Z					

Electrical properties

Pitch P (mm)	1.00	1.25/1.27	1.90	2.00	2.54	5.08
Max. current rating at 20°C (A)	1	1.6	2.0	2.0	3.0	3.0
Max. voltage rating (VAC)	60	60	300	300	300	300

UL approval

UL certification on request.

Identification code

RFC 2.54 B 10 /0100 H 4.0 - 3.5 - 08.0 - 00.0 S A L-

Type of reinforcement:

L : blue ; "-" without reinforcement

Tape marking :

A : Not marked

Conductor thickness

Standard

Reinforcement length in mm

Default F1=08.0 mm

Strip length in mm

Type B default S1=4.0 ; S2=3.5

Type C default S1=S2=3,5

Type of insulation tape

(see above table)

Insulated length (mm)

Number of conductors

Type of end

B: round conductors on one end,
flat conductors on the other end

C: round conductors on both ends.

Pitch

Round-to-flat Cable:

AXOSTRIP®

Bulk Flat Flexible Cables

FLEXLINK® is a range of flat flexible cables supplied on the reel for any application where space reduction and flexibility are the most important criteria.

They can be installed in printers and computers for consumer electronics, used for special machines or for board-to-board connections. Bulk flexible flat cables can also be used for the cabling of switch rotary connectors for airbag® modules. AXON' offers standard as well as custom designed versions for switch rotary connectors.

Standard bulk Flat Cables FLEXLINK®

Advantages

- Very flexible cables,
- Space saving cabling,
- Compatible with most crimp contacts.

General characteristics

- Temperature rating:
 - Polyester insulation: -40°C to +105°C
 - Polyimide insulation: -90°C to +200°C
- Standard packaging:
 - 150 m for Polyester insulated flat cables,
 - 20 m for Polyimide insulated flat cables,
- Bare copper or tin plated copper conductors,
- Polarization on track 1 if required.



BULK FLAT FLEXIBLE CABLE PRODUCTION

General drawing

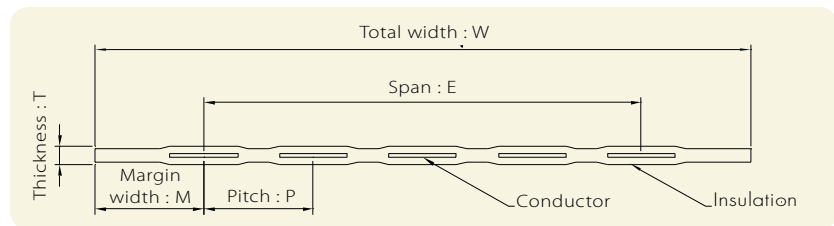

Dimensions

Conductor reference	S	M	L
Pitch P (mm)	1.27	2.54	2.54
Total width W (mm)	1.27 x (N+1)	2.54 x (N+1)	2.54 x (N+1)
Margin width M (mm)	1.27	2.54	2.54
Cable thickness T (mm) for Polyester version	0.28	0.28	0.28
Cable thickness T (mm) for Polyimide version	0.20	0.20	0.20

Electrical properties

Conductor characteristics		S	M	L
Current rating (A)		0.9 max.	3.0 max.	
Voltage rating (V A.C.)		300 max.		
Insulation resistance conductor to conductor (M Ω . m min)		10		
Capacitance (typical value at 1KHz)	Cb (balanced, pF/m)	52	40	33
	Co (unbalanced, pF/m)	75	56	46
Impedance (typical value at 1KHz)	Zb (balanced, Ω)	162	157	180
	Zo (unbalanced, Ω)	110	110	130
Resistance (Ω /km max) at 20°C		440	194	240

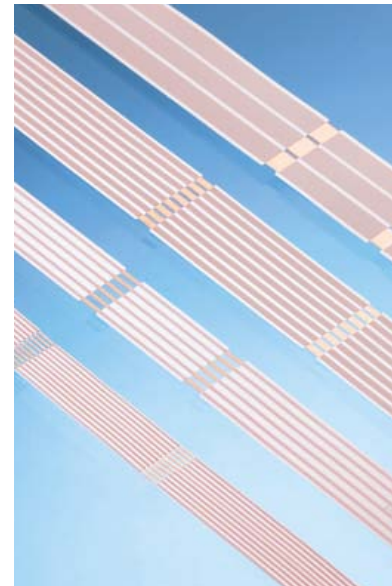

BULK FLAT CABLE

Special assemblies

Flexlink® cable with crimped contacts



Connector assemblies on request.

Identification code

M 1 S P 55

NUMBER OF CONDUCTORS

For 1.27 pitch : 4 to 55
For 2.54 pitch : 2 to 38

CONDUCTOR MATERIAL

T = Tin plated
U = Bare copper
P = Polarization: First conductor : tin plated.
Others : bare copper.

CONDUCTOR SIZE

For 1.27 pitch: S = 0.66 x 0.076
For 2.54 pitch: L = 1.27 x 0.076
M = 1.57 x 0.076

PITCH

1 = 1.27 mm
2 = 2.54 mm

INSULATION MATERIAL

M = Polyester
H = Polyimide (only available with bare copper conductors)

Custom-designed cables for switch rotary connectors

General characteristics

Conductor

Thickness : between 0.035 and 0.20 mm.

Width : between 0.80 and 10 mm.

Copper or tin plated copper.

Different conductor widths can be mixed in the same hybrid cable.

Insulation

Polyester insulation with flame retardant adhesive.

Processing forms

Hotbar soldering

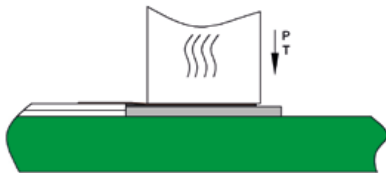

Electrical welding

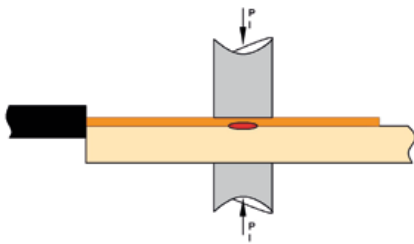

Ultrasonic welding

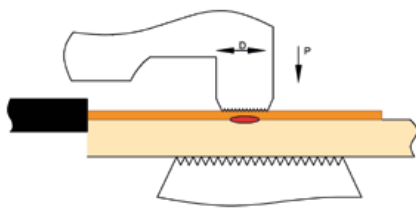

P : PRESSURE - T : TEMPERATURE - I : CURRENT - D : MOVEMENT



BULK FLAT CABLE



CABLE ASSEMBLY FOR SWITCH ROTARY CONNECTOR

Specific tests

- Flexion,
- Torsion,
- Dry heat or with humidity,
- Salt spray,
- Cassette rotation test (between -40°C/+90°C with or without humidity).

Don't hesitate to contact us for specific requirements.

Flat Cable Assemblies

FDC-Flat Display Connections AXOLINK®

FDC-Flat Display Connections are made from AXOJUMP® Flat Flexible Cables and industry standard display connectors such as DF-9, DF-19, FI-SE or FI-X.

Advantages

Small dimensions: low profile, narrow width design,
Low cost, high reliability,
Excellent flexibility and flex-life.

General characteristics

0.50 mm, 1.00 mm and 1.25 mm pitches,
Standard FFC, ZIF interface
FDC with DF-9 cable assemblies are compliant with VESA (Video Electronics Standard Association) FPGI-1 (Flat Panel Display Interface),



31 WAY FDC WITH DF-9 CONNECTOR

Product availability

	Connector type			
	DF-9**	DF-19*	FI-SE*	FI-X*
FFC type				
0.50 (mm)	x			
1.00 (mm)		x		x
1.25 (mm)			x	
Number of conductors				
14		x		x
20		x	x	x
30		x		x
31	x			
41	x			

*Standard version is shielded for these connector types. Non shielded versions also available.

**Standard version is non-shielded (shielded version on request).

All versions can be supplied with custom folds.

Processing forms

■ M: Header
■ F: Receptacle

DF9

Non-shielded version (FDC), Shielded version on request.

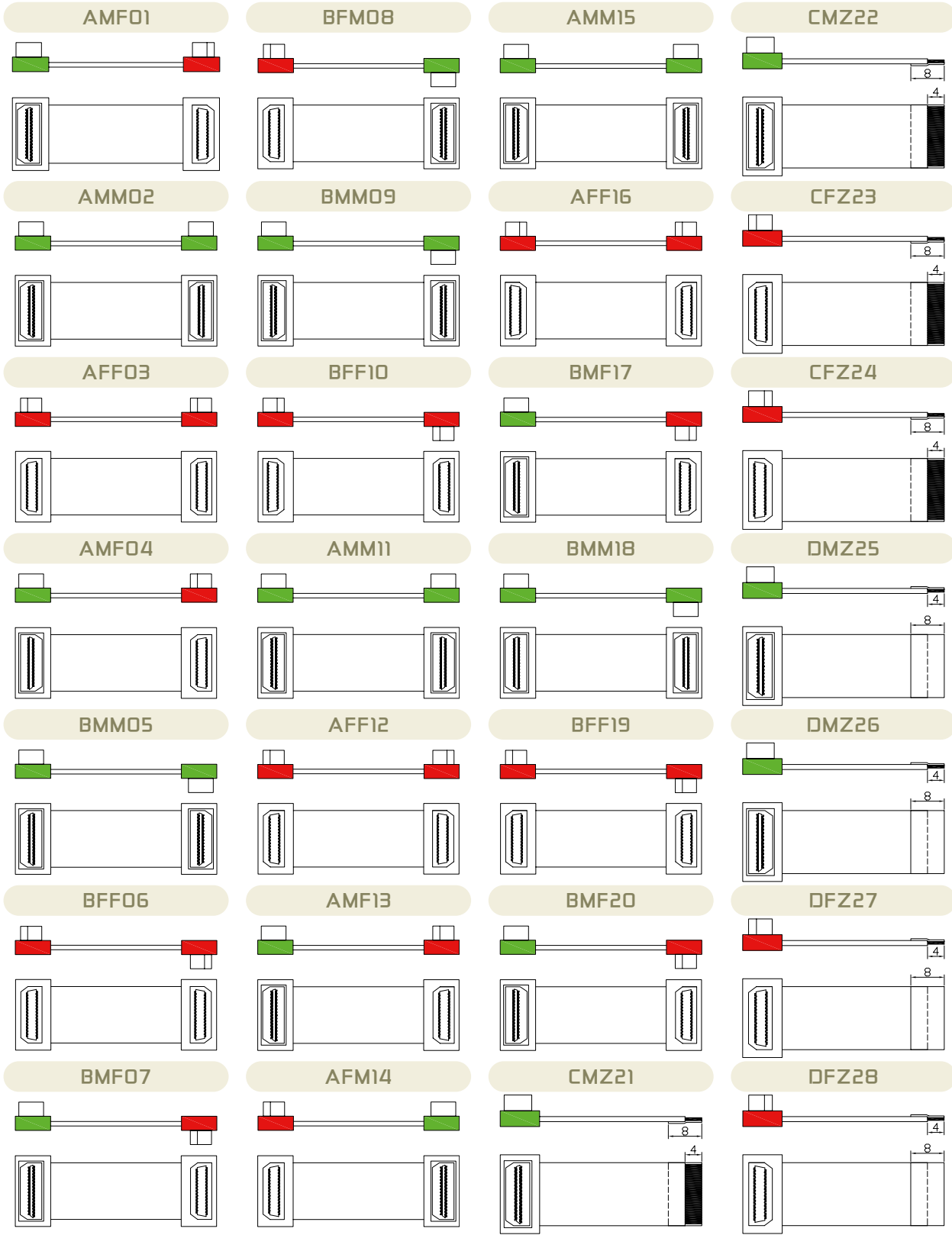

DF19

Non-shielded version (FDC), shielded version (FDB).

EMM29

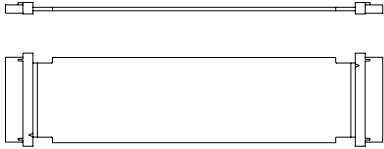

EMM30

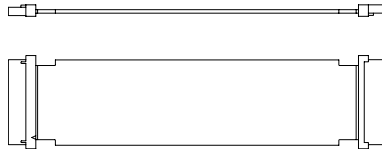

FMZ31

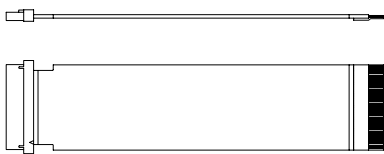

FMZ32

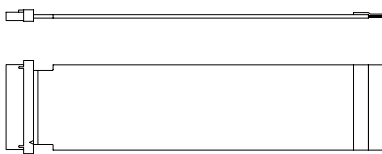

FDC WITH DF-19 CONNECTOR

FI-SE

Non-shielded version (FDC), shielded version (FDB).

EMM33

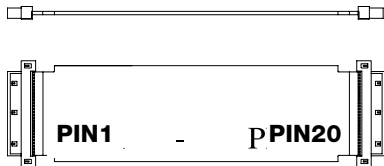

EMM34

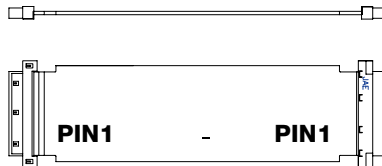

FMZ35

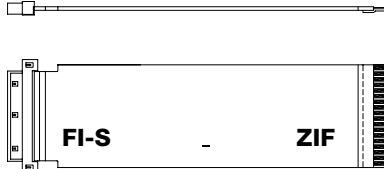

FMZ36

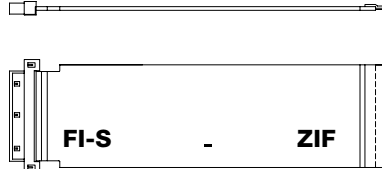

41 WAY FDC WITH DF-9 CONNECTOR

FI-X

Non-shielded version (FDC), shielded version (FDB).

EMM37

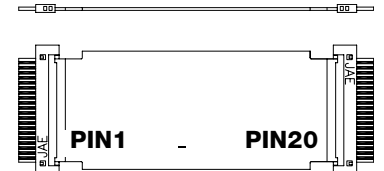

EMM38

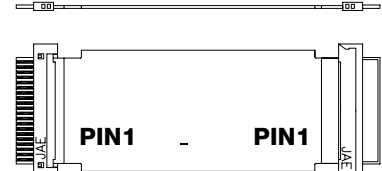

FMZ39

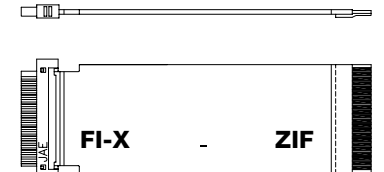

FMZ40

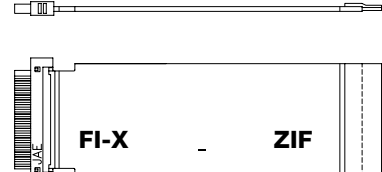

41 WAY FDC WITH DF-9 CONNECTOR

Dimensions

DF-9

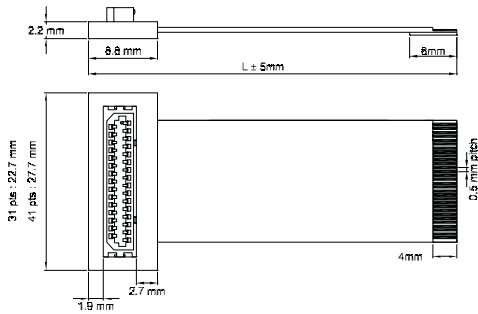

DF-19

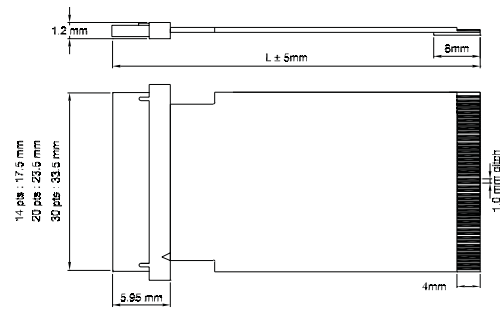

FI-SE

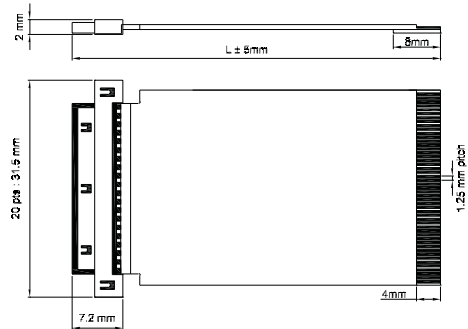

FI-X

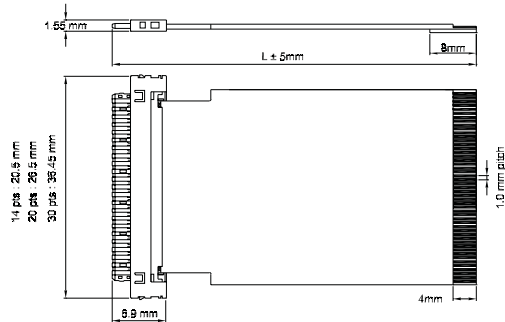

Where there is a ZIF connector at one end, the standard number of ways for the ZIF will be 2 more than the DF-19/FI-SE/FI-X connector at the other end (for DF-9 versions the number of ways is equal for both connectors). If same number of ways (14, 20 or 30) is required for the ZIF on DF-19/FI-SE/FI-X versions, AXON' can punch the ZIF end to ensure compatibility.

Off-the-shelf products

AXON' keeps several standard lengths of Flat Flexible Cables in stock with 31 or 41 conductors for the different assembly types to assure a short delivery time. Immediately after receipt of your order, the termination process is started. Any connector configuration shown on the following pages is possible.

Standard AXOLINK® assembly lengths

- 76 mm
- 102 mm
- 152 mm
- 203 mm
- 254 mm

Processing forms

Connection schemes

Only for
DF-9

A

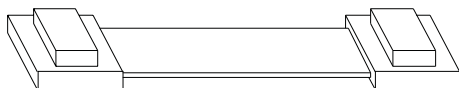

B

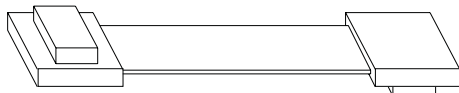

C

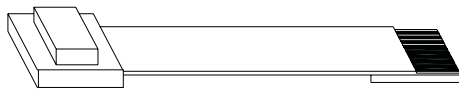

D

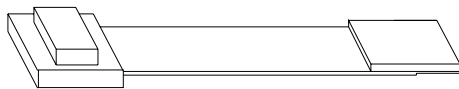

Only for
DF-19, FI-SE and FI-X

E

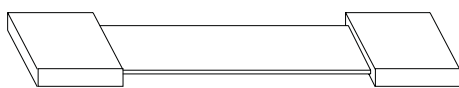

F

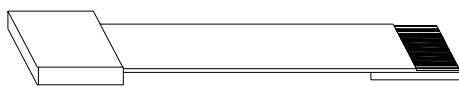

For "ZIF" ending of DF-19 / FI-SE / FI-X versions, connector ways = number of conductors + 2.

Quick prototyping for electrical validation

AXON' can provide small quantities of AXOLINK® prototypes for electrical validation. Dependent on the availability of cable, AXON' may propose the exact length required or a slightly different length to provide the quickest response.

Special products

AXON' can also provide special AXOLINK® products, in particular:

- special number of connectors
- special markings,
- any special length,
- moisture protection of the assembly,
- folded versions,
- ferrites on the assembly,
- shielding,
- shielding with grounding,
- gold plating: for DF-19/FI-SE and FI-X the gold plating available on the ZIF end.

Identification code

FDC 41 / 0100 A M M 02

Connection scheme

1 through 40 as defined on the connection scheme

Connector type C2

M : MALE (Header) - DF-9 / DF-19 / FI-SE / FI-X
F : FEMALE (Receptacle) - DF-9 only
Z : ZIF

Connector type C1

M : MALE (Header) - DF-9 / DF-19 / FI-SE / FI-X
F : FEMALE (Receptacle) - DF-9 only

Connection type

A : connector-connector - same face
B : connector-connector - opposite face
C : DF-9 to ZIF - same face
D : DF-9 to ZIF - opposite face
E : connector - connector (only for DF-19 / FI-SE / FI-X)
F : connector - ZIF (only for DF-19 / FI-SE / FI-X)

Length

End to end length including connector (mm)
(minimum length : 52 mm)

Number of conductors

31 or 41 for DF-9
14, 20 or 30 for DF-19
20 for FI-SE
14, 20 or 30 for FI-X

FDC = Non shielded version

(DF-9, DF-19, FI-SE, FI-X connectors)

FDB = Shielded version

(DF-9, DF-19, FI-SE, FI-X connectors)

Any special version on request

Flat Display Connections for High Speed (LVDS) and Ultra High Speed (UHS) transmission: FDC 100®

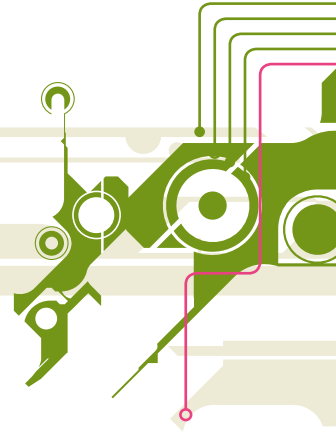

FDC 100® is a 100 ohm shielded Flat Cable Assembly, designed for connecting HD and ultra high definition flat displays.

The FDC 100® is the connection between the motherboard to the display on larger HD television displays (LCD LED, plasma and LCD monitors).



FDC 100® UHS - ZIF VERSION

Advantages

- Connector with a simple connection system: no need to have an extra metal link between the PCB connector and the cable shield.
- Foldable to make installation easier.
- Small size.
- High flexibility.
- 100 Ω impedance.

UHS cables are compatible with the V-by-One® HS protocol



General characteristics

- Made with a shielded flat cable only or a shielded flat cable connected with an innovative connector designed by AXON'.
- 21, 31, 41 and 51 way 0.50 mm pitch shielded flat cable with gold plated conductor ends, terminated with connectors compatible with the board-mount FI-R connectors.
- Compatible with ZIF Molex and FH41 Hirose connectors.

General drawing

FDC 100® - 0.50 mm pitch

Connector compatible with FI-R PCB mounted connector.

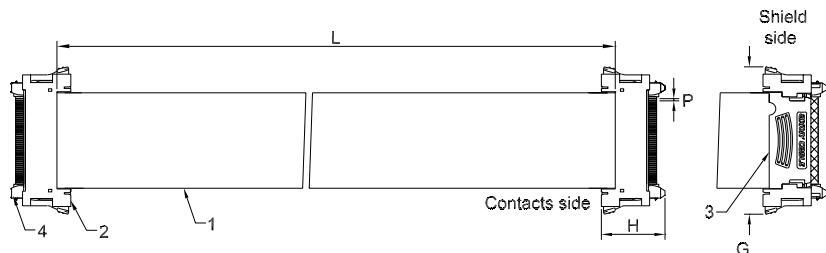

FDC 100® with FI-R connectors

Dimensions

Items	Materials and Finishes	
1	FFC	PET, copper, contact, gold plating
2	Connector – Housing	AXON'connector mating to FI-R
3	Connector – Cover	
4	Clip	

Items	Specifications			
Number of conductors N	21	31	41	51
Pitch P	0.50 +/- 0.05 mm			
Length L	L +/- 5 mm			
Connector height H	14.95 mm			
Connector width G	25.30 mm	30.30 mm	35.30 mm	40.30 mm

Electrical properties for cable

Contact resistance	< 40 milliohms max
Insulating resistance	10 Mohm.m min (200 VDC)
Dielectric withstanding voltage conductor to shield	200 VAC RMS (for 1 minute)
Operating voltage	30 VAC max.
Impedance	100 +/- 10 ohms
Operating temperature	-40°C to +80°C
Humidity resistance	48H – 85°C / 95% humidity
Vibration resistance	OK (Acc 4g/ shock resistance 6g 10 ms)
Interconnection with FI-R connectors.	20 mating cycles: no change of electrical parameters.

Eye pattern FDC 100® UHS (for 700 mm length cables)

At 620 Mb/s (FI-R)

Without fold

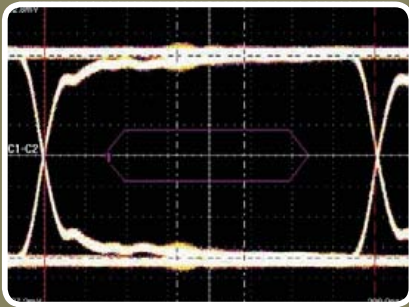

With 10 folds on the cable

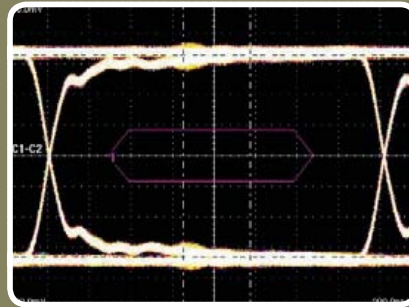

At 4 Gb/s (FI-R)

Without fold

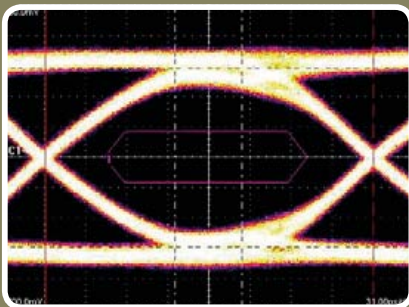

With 10 folds on the cable

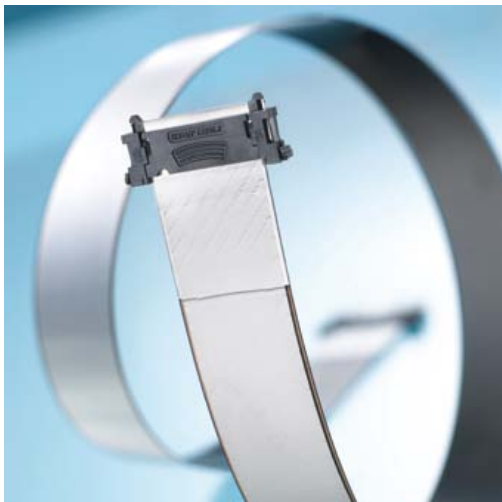
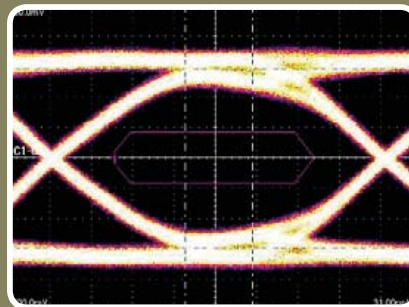

FDC 100® - UHS

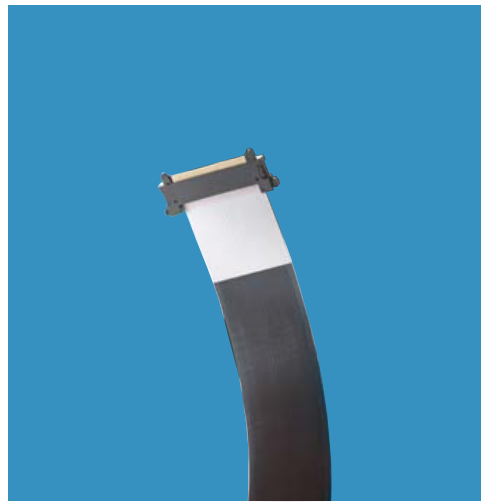

FDC 100® - UHS

Eye pattern FDC 100® LVDS (for 500 mm length cables)

At 50 Mbit/s

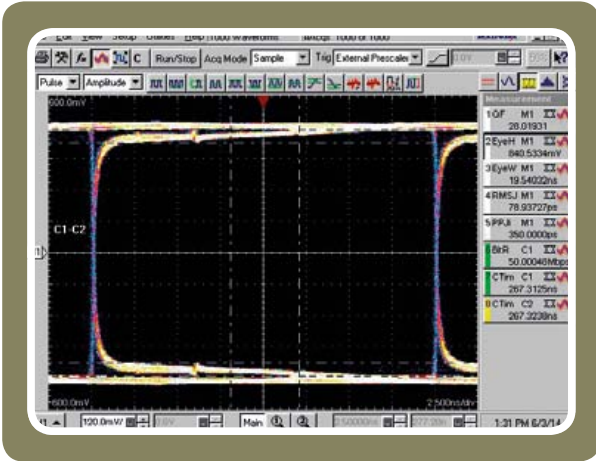

At 500 Mbit/s

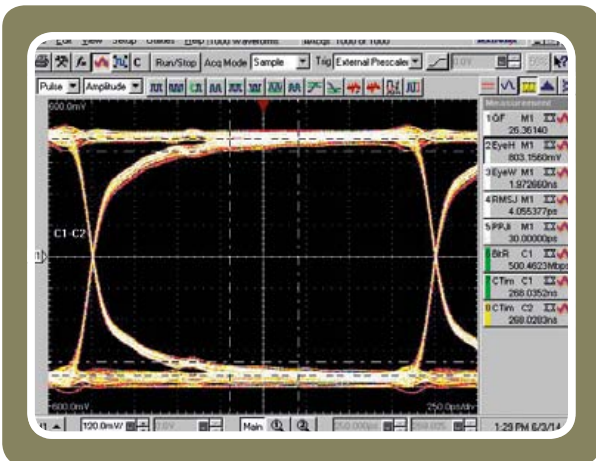

At 1000 Mbit/s

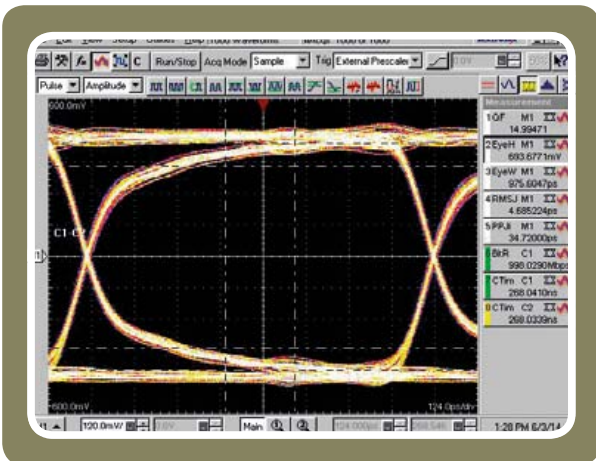

FDC100® LVDS

FDC 100® for ZIF connectors

Version for Molex 502231

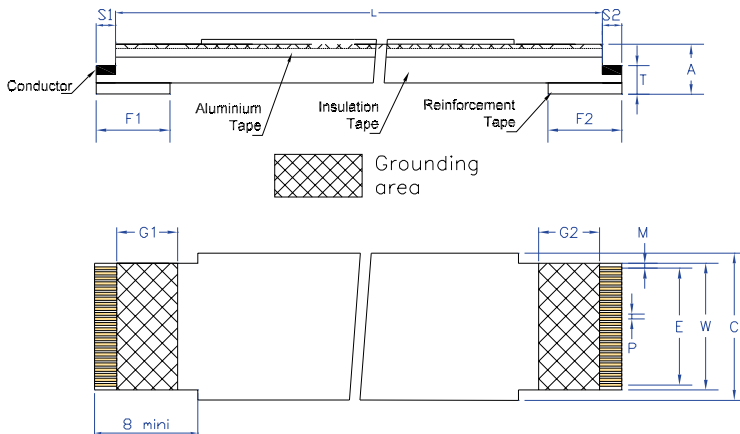

Pitch : P	0.50 ± 0.05 mm
Span : E	(N-1)*0.50 ± 0.05 mm
Width : W	(N+1)*0.50 ± 0.07 mm
Width : C	(N+5)*0.50 ± 0.15 mm
Margin : M	0.5 ± 0.08 mm
Strip length : S1/S2	2.2 ± 0.5 mm
Grounding length : G1/G2	6 ± 2.0 mm
Reinforcement length : F1/F2	7 ± 1.5 mm
End thickness : T	0.30 ± 0.05 mm
Thickness grounding Area : A	0.50 ± 0.05 mm
Insulated length : L	45 to 60 ± 2 mm
	61 to 100 ± 3 mm
	101 to 200 ± 4 mm
	201 to 1500 ± 5 mm

Version for Hirose FH41

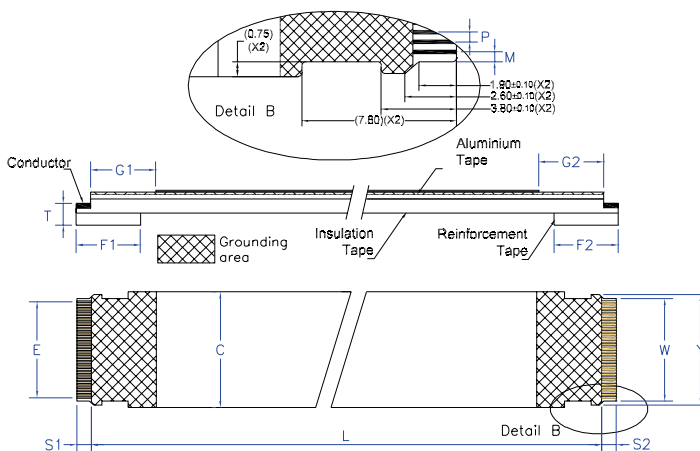





Pitch : P	0.50 ± 0.05
Span : E	(N-1)*0.50 ± 0.05
Width : W	(N+1)*0.50 ± 0.07
Width : C	(N+5)*0.50 ± 0.15
Margin : M	0.5 ± 0.08
Margin : Y	(N+1)*0.50+1.2 ± 0.10
Strip length : S1/S2	2.2 ± 0.5
Grounding length : G1/G2	6 ± 2.0
Reinforcement length : F1/F2	7 ± 1.5
End thickness : T	0.30 ± 0.05
Insulated length : L	45 to 60 ± 2
	61 to 100 ± 3
	101 to 200 ± 4
	201 to 1500 ± 5

Electrical properties

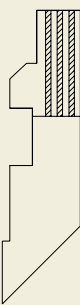
Insulation resistance	10 Mohm.m min (200 VDC)
Impedance	100 +/- 10 ohms
Dielectric withstanding voltage conductor to shield	200 VAC RMS (for 1 minute)
Operating voltage	30 VAC max
Operating temperature	-40 °C to +80 °C
Humidity resistance	48H -85°C / 95% humidity

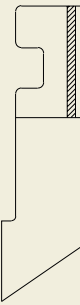
Special designs

Pitch: P (mm)	0.50	0.50	0.50	0.50
FFC Drawing				

Identification code

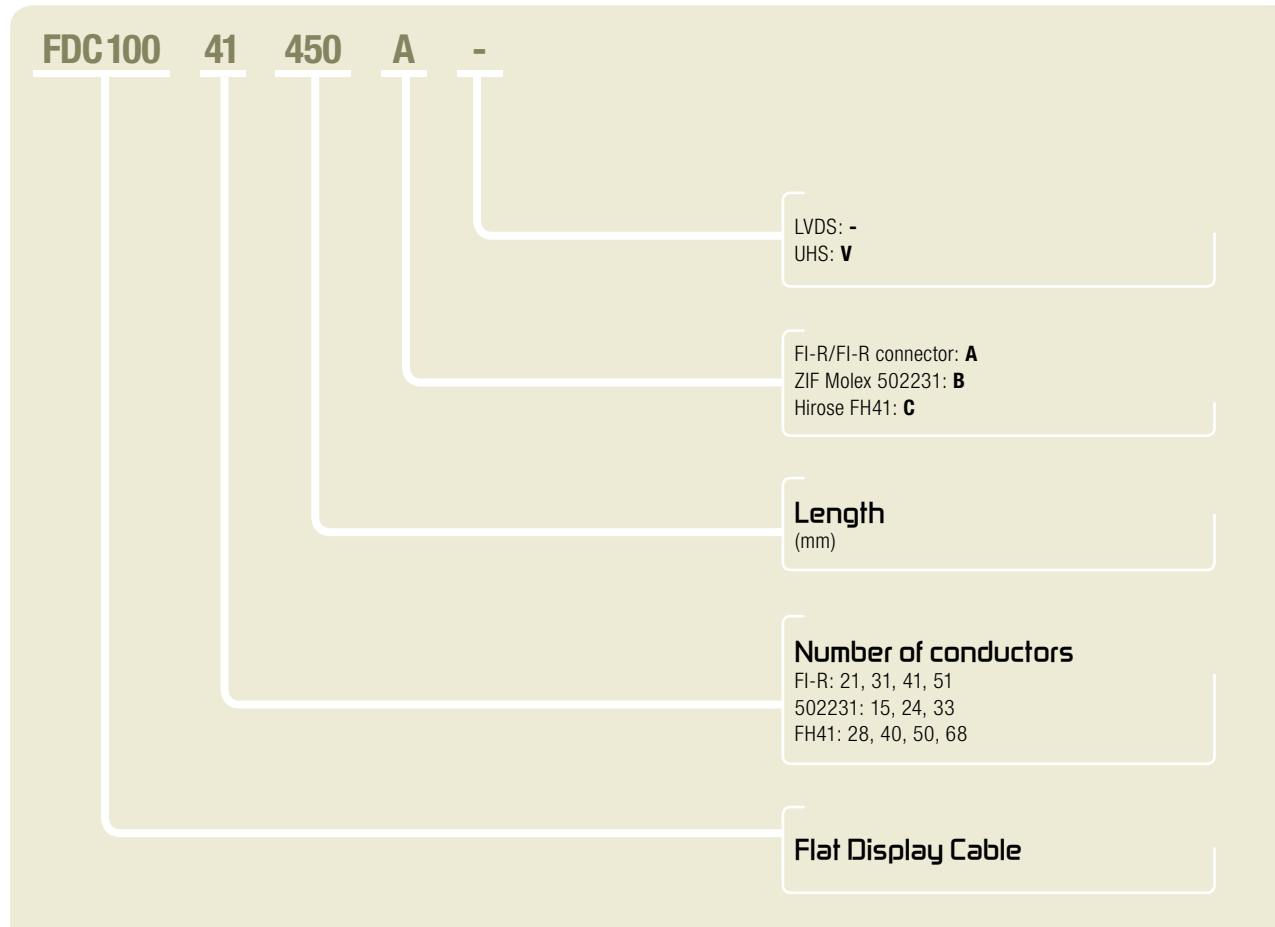



© 2009 - AXON'CABLE-Released October 2014/B - All rights reserved
AXOJUMP®, AXOSTRIP®, FLEXLINK®, FDC 100®, AXOLINK®:
Registered trademarks of AXON'CABLE - Photos: Nickelkrome
All information contained in this brochure can be changed without prior notice

>> BRAZIL

AXON' CABLE IND E COMÉRCIO LTDA
AV. AFONSO ARINOS DE MELO FRANCO Nº222
SALA 276 BLOCO 2 B
BARRA DA TIJUCA, RIO DE JANEIRO-RJ
22631-455
e-mail: l.moreira@axon-cable.com

>> CHINA

AXON' INTERCONNECT LIMITED
HIGH TECH INDUSTRIAL PARK,
CHANG BAO XI ROAD
RONGGGUI, 528306
SHUNDE, GUANGDONG
TEL: + 86 757 2838 7200
FAX: + 86 757 2838 7212
e-mail: sales@axon-interconnect.com

>> GERMANY

AXON' KABEL GmbH
POSTFACH 1131 - 71201 LEONBERG
HERTICHSTR. 43 - 71229 LEONBERG
TEL: +49 7152-97992-0
FAX: +49 7152-97992-7
e-mail: sales@axon-cable.de

>> HUNGARY

AXON' KÁBELGYÁRTÓ KFT.
H-6000 KECSKEMÉT,
WÉBER EDE U. 10/A
TEL: +36 76 508 195
FAX: +36 76 508 196
e-mail: axon@axon-cable.hu

>> INDIA

AXON' INTERCONNECTORS
AND WIRES PVT Ltd
#117, Neil Rao Towers, Suite NO. 1W,
ROAD NO:3, EPIP, WHITEFIELD
BANGALORE 560066
TEL: +91 80 40918186
FAX: +91 80 40918185
e-mail: sales@axon-cable.in

>> JAPAN

AXON' CABLE JAPAN OFFICE
ML 141-0043
Ginza 2-14-8, Chuo-Ku,
TOKYO 104-0061
TEL/FAX: +81 26 244 2261
e-mail: axon-japan@nifty.com

>> LATVIA

AXON' CABLE SIA
Višku Iela, 21 C - LV-5410 DAUGAVPILS
TEL: +371 6540 78 91
FAX: +371 6540 78 93
e-mail: axon@axoncable.lv

>> MEXICO

AXON' INTERCONEX, S.A. DE C.V
Av. Peñuelas 21-A1.
Industrial San Pedro Peñuelas
Querétaro park
76148 Querétaro, QRO. - MÉXICO
TEL: +52 442 215 2713
FAX: +52 442 220 6464
e-mail: b.aguilar@axoncable.com

>> SPAIN

AXON' CABLE SPANISH OFFICE
C/Capitán Haya, Nº1, Planta 15
28020 MADRID
TEL: +34 91 418 43 46
FAX: +34 91 556 28 80
e-mail: sales@axon-cable.com

>> UNITED KINGDOM

AXON' CABLE Ltd
AXON' AGORA
ADMIRALTY PARK - ROSYTH - DUNFERMLINE
FIFE - KY11 2YW
TEL: +44 1383 421500
FAX: +44 8715 282 789
e-mail: sales@axon-cable.co.uk

>> USA

AXON' CABLE INC.
1314 N. PLUM GROVE ROAD
SCHAUMBURG, IL. 60173
TEL: +1 847 230 7800
FAX: +1 847 230 7849
e-mail: sales@axoncable.com

HEADQUARTERS

>> France

>> AXON' CABLE S.A.S.

2 ROUTE DE CHALONS EN CHAMPAGNE - 51210 MONTMIRAIL
TEL : +33 3 26 81 70 00 - FAX : +33 3 26 81 28 83
e-mail : sales@axon-cable.com - <http://www.axon-cable.com>